

RadioMate

Radio Automation Made Easy



A Freifunk+Ninux GSoC project
Wireless Battlemesh v4
Claudio Pisa - clauz@ninux.org



Community Webradios

- Fusoradio (Rome)
- Radio Blau (Leipzig)
- radioCona (Ljubljana)
- ... ← TBD: involve other webradios



Fusoradio



- Webradio in Rome
 - Ninux HQ: Fusolab
- Distributed Wjs
 - Stream from home
- But:
 - Server-side uses close-source software



- Audio Stream Generator
- Can mix into one stream different sources:
 - Playlists
 - Audio files
 - Live streams
- But is missing:
 - Timetable handling
 - Users, audio files, playlists management
 - A JSON API



the big picture

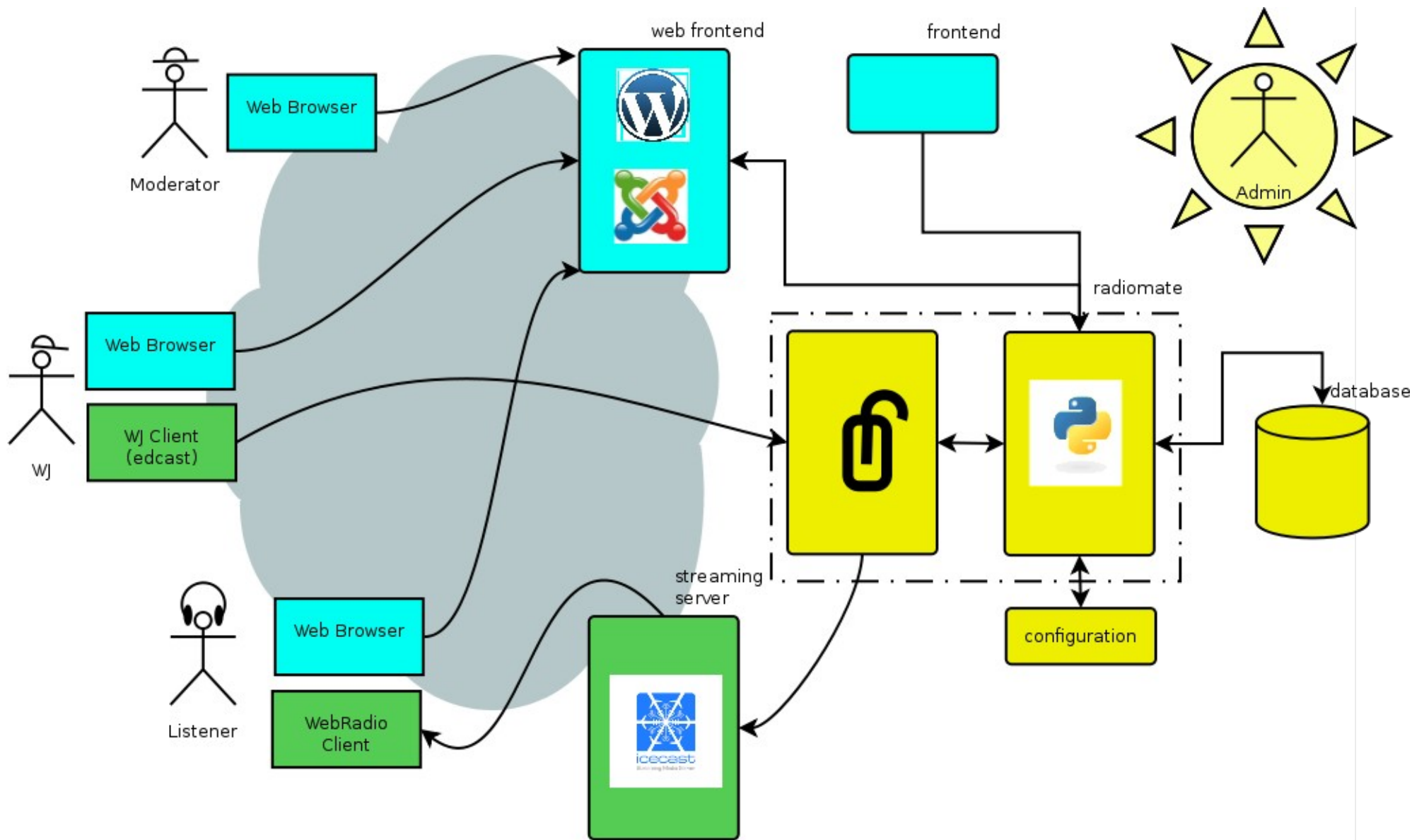

Radiomate

- Source code (Python + liquidsoap) available at
 - <http://radiomate.org>
- Developed for the Google Summer of Code 2010



Radiomate - scheduling

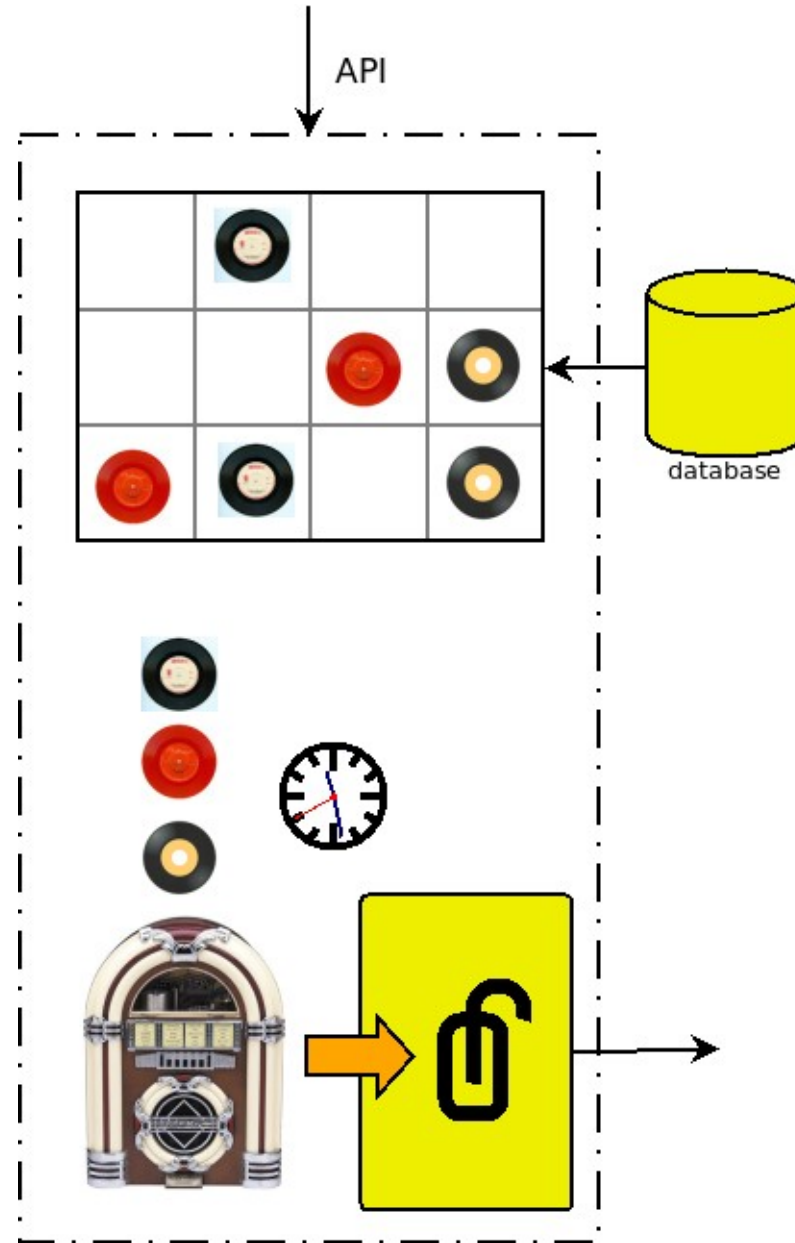

Radiomate - timeslots

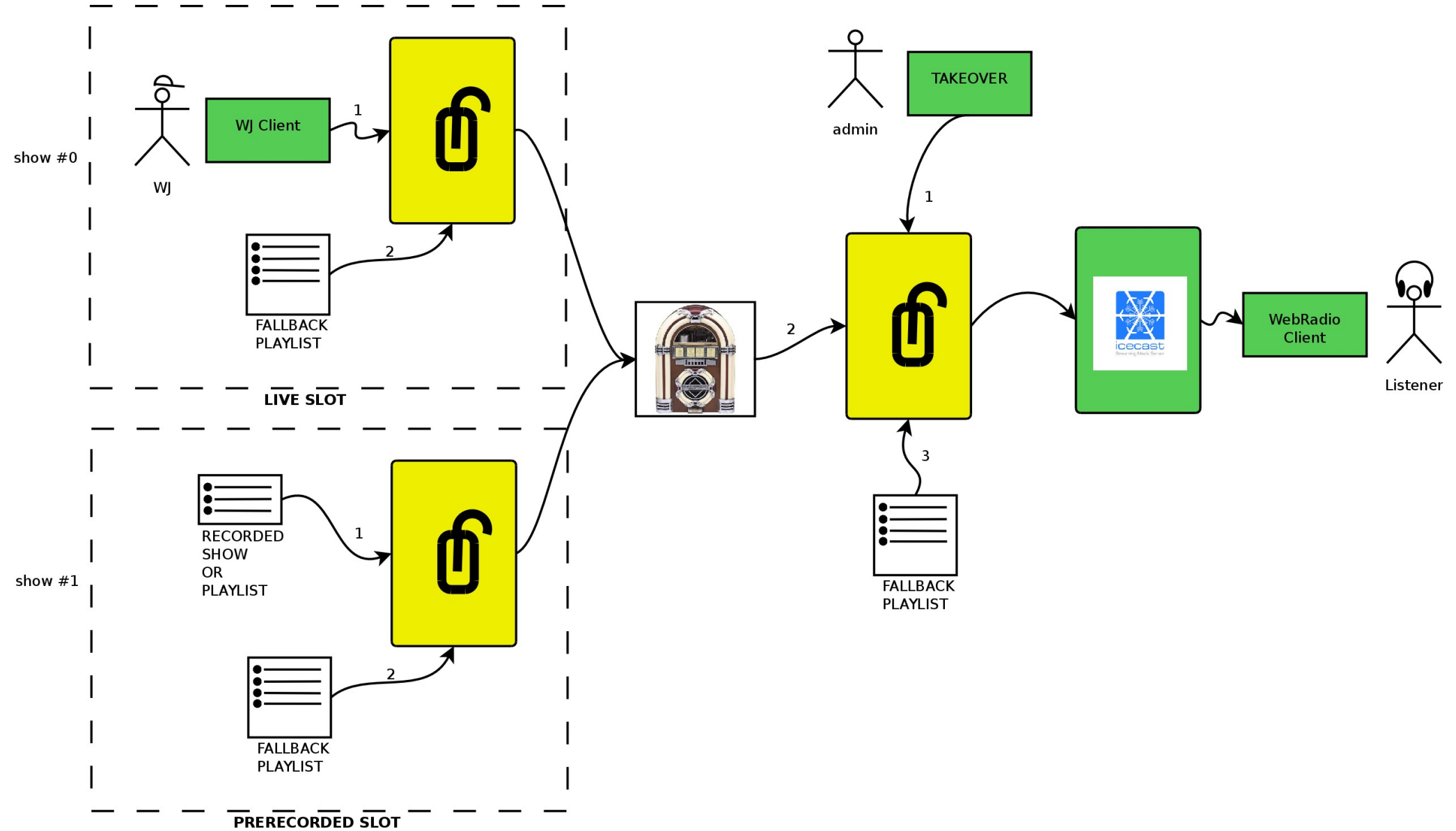

Radiomate – slot types

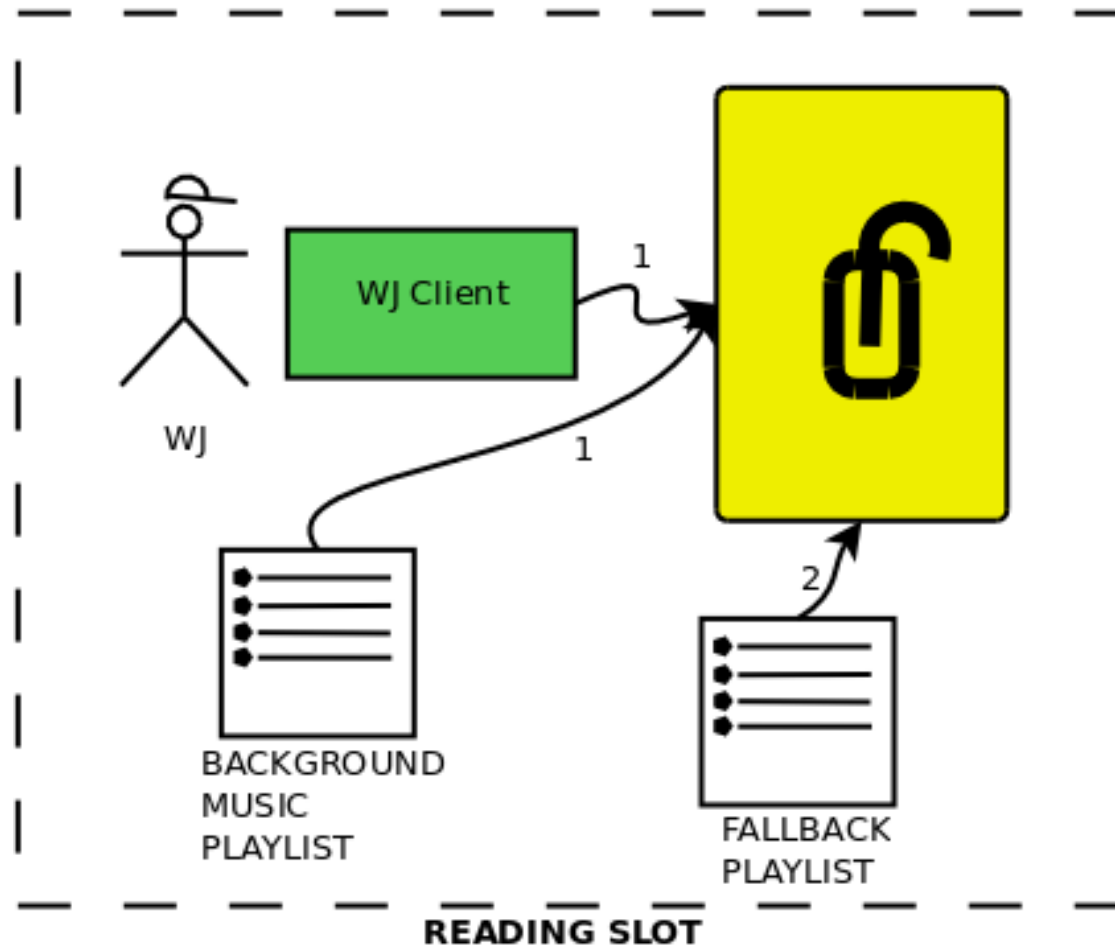

Radiomate – slot types

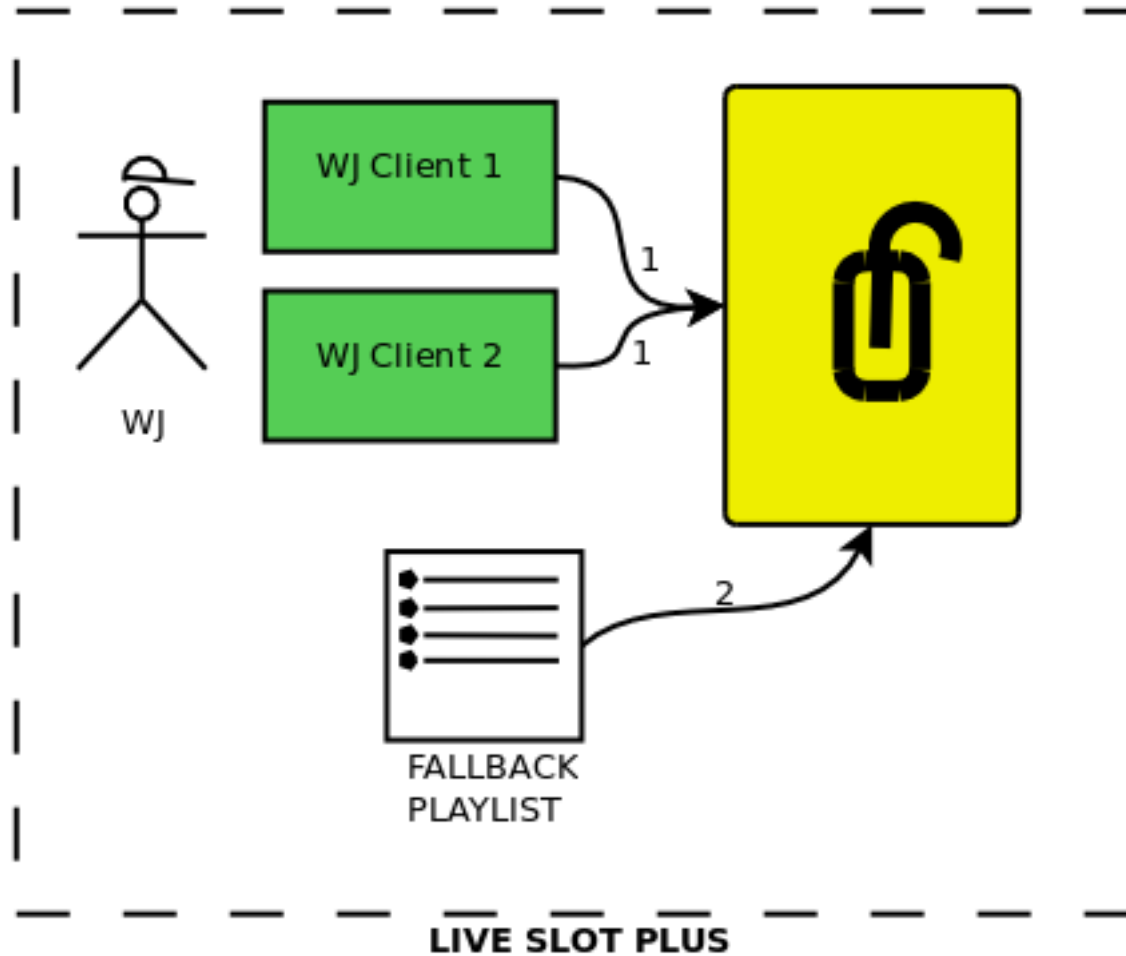

Radiomate – slot types

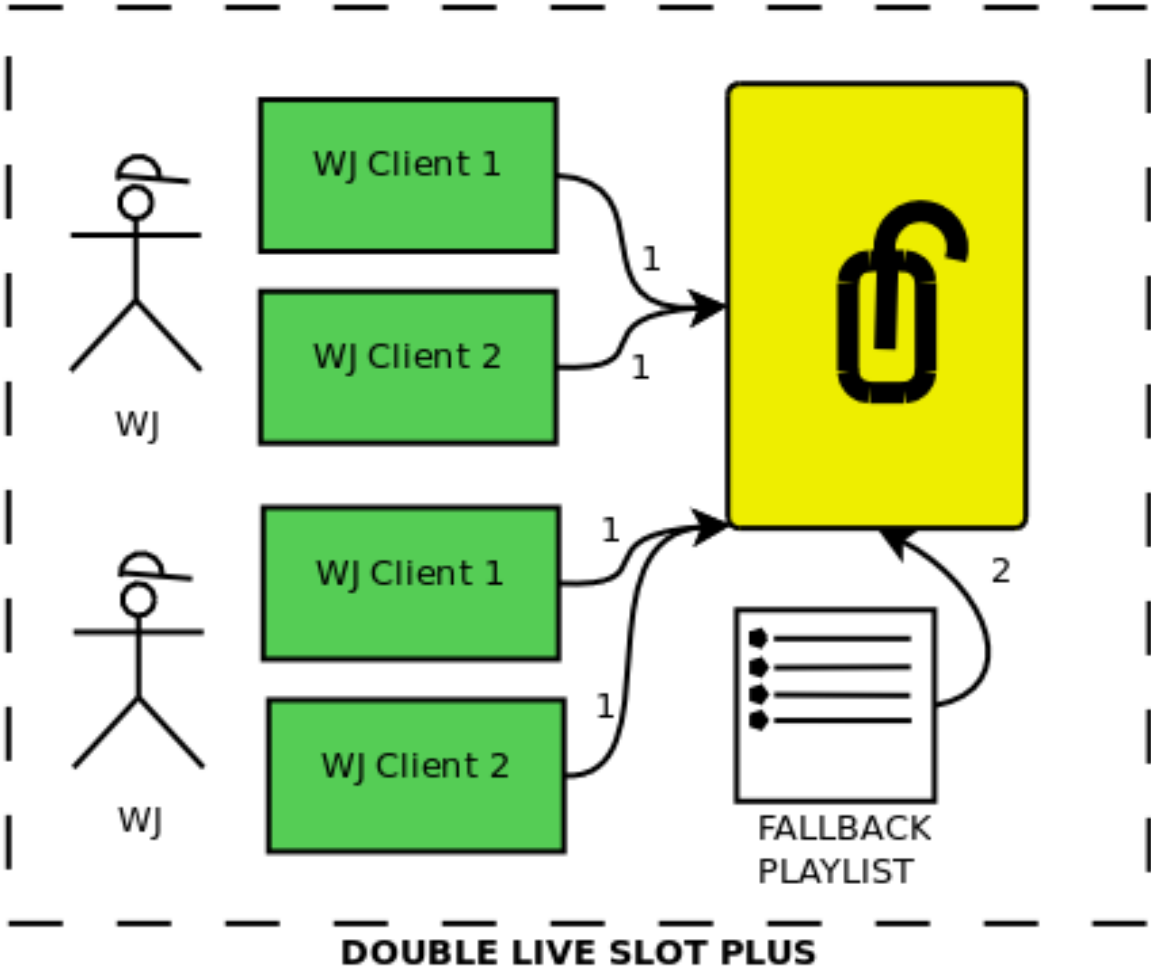

Radiomate – slot types

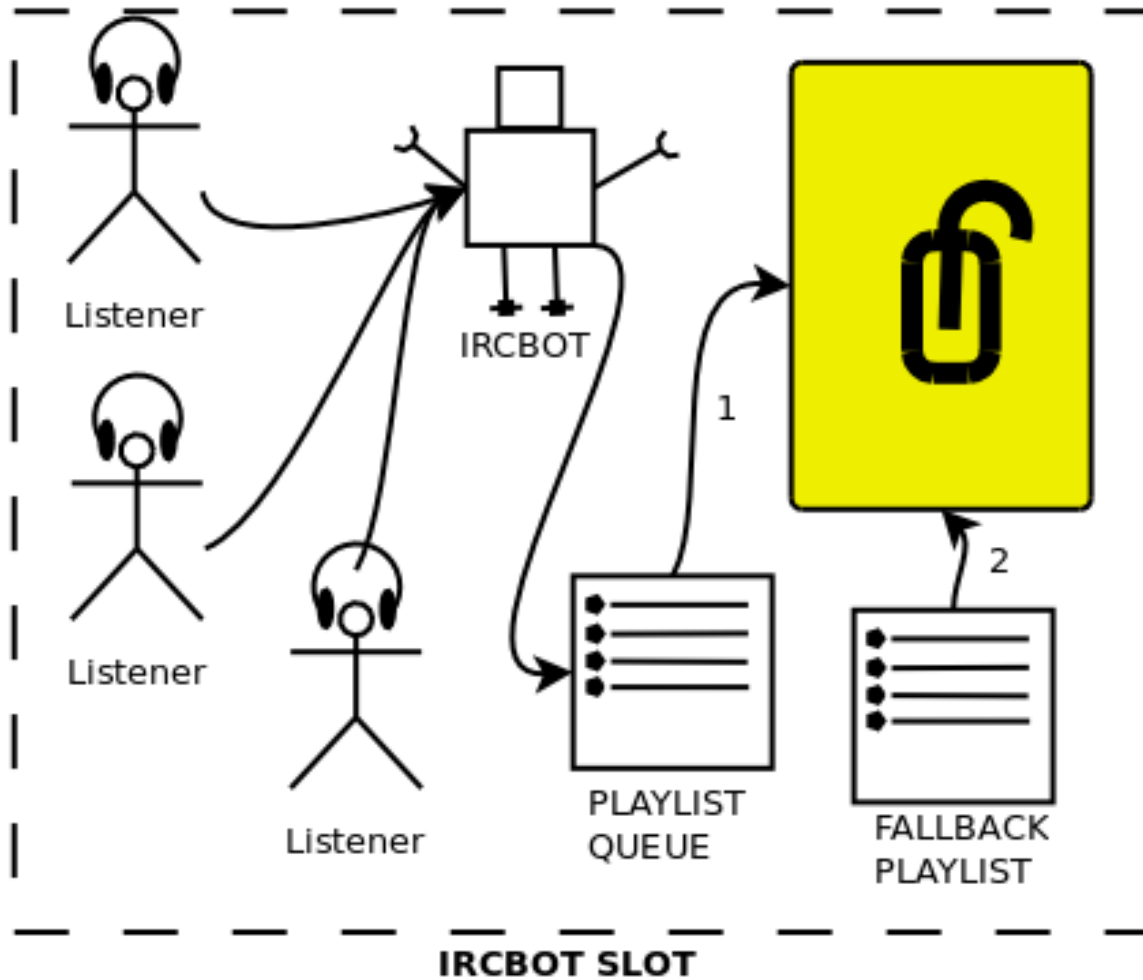

frontend(s) missing

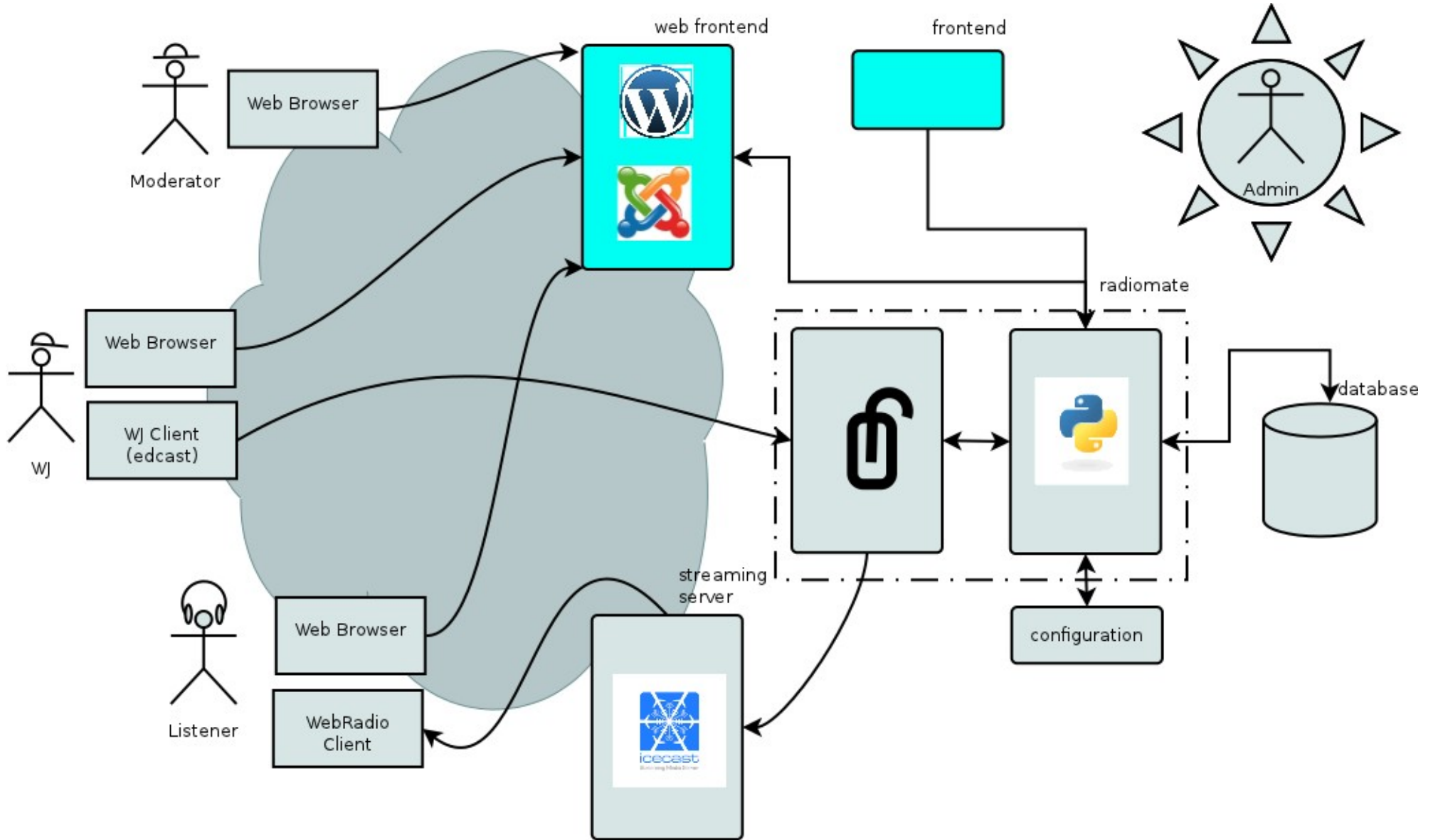

Thank you



Wireless Battlemesh v4
March 2011
Sant Bartomeu del Grau
Claudio Pisa - clauz@ninux.org

